

PRODUCT NO.	DSIC02LJGET
RoHS compliant	

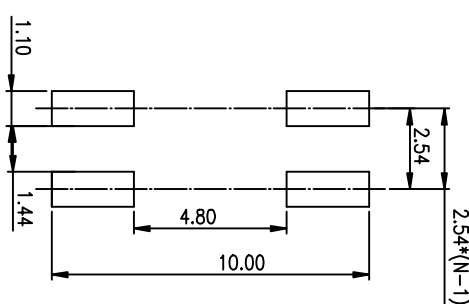

RECOMMENDED P.C.B. LAYOUT (TOP VIEW)

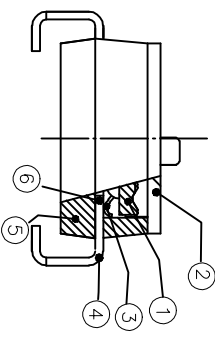
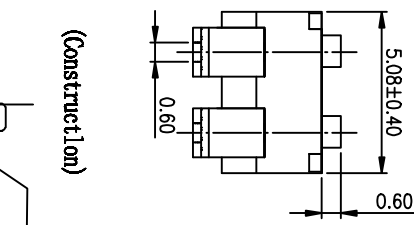
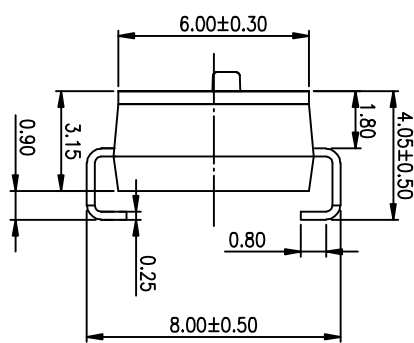
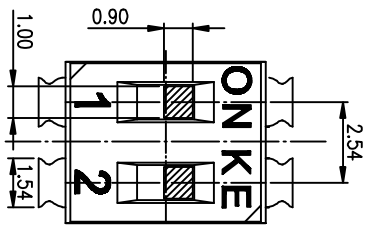
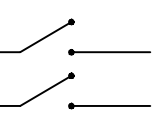

[Schematic]

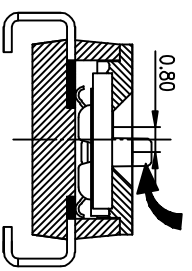

[推針行程]

- NOTES :
- 1.Specification:
- 1>.Operating force:1000gf Max
 - 2>.Operating Temperature: -40° to+85°
 - 3>.Storage Temperature: -40° to+85°
 - 4>.Mechanical Life: 3000cycles minimum
 - 5>.Electrical Life: 2000cycles 25mA 24VDC
2. PLATING:
- GOLD FLASH 1u"(min.) SOLDER TAIL,
3u" GOLD PLATING ON THE CONTACT AREA,
WITH 50u" NICKEL UNDERPLATINGOVERALL.

3. PART NUMBER DESCRIPTION

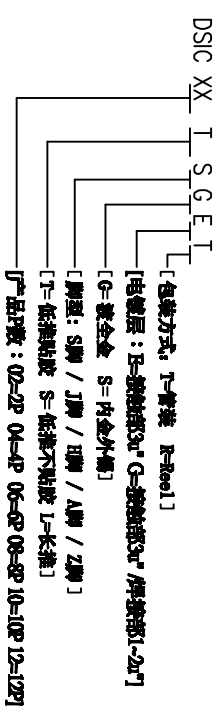

Number	Part Name	Material	Finished
①	Actuator	UL94 V0	White
②	Cover	UL94 V0	Black
③	Movable	Copper Alloy	3u"Gold
④	Terminal	Brass	1u"Gold
⑤	Base	UL94 V0	Black
⑥	Terminal Contact	Brass	3u"Gold

TOLERANCE UNLESS OTHERWISE SPECIFIED		INSPECTION COPY	
LINER	ANGLES	PROJECTION	
0 ± 0.25	0. ± 2°	0.80	
.00 ± 0.15	.0 ± 1°		
.000± 0.10	.00± 0.5°		
DESIGN	kathy	2012/04/12	
DRAWING			
CHECK			
APPRO.			

FILE NO.	DSIC02LJGET-A
SIZE	UNIT SCALE
A4	mm
2	: 1
10F	1
A	A

東智精密電子股份有限公司
Dongguan Kingtek Industrial Co., Ltd.

BY DSIC SERIES PITCH 2.54mm

PRODUCT FAMILY DSIC SERIES

PRAT NO. DSIC02LJGET