

PRODUCT NO.	DISC06LJGET
NO.	RoHS compliant

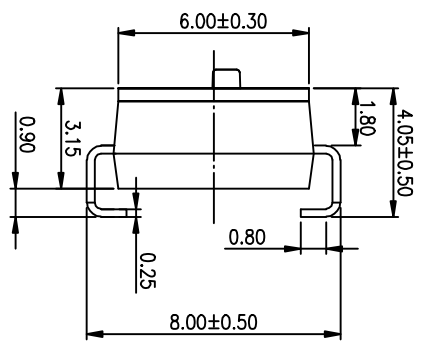

- NOTES :
- 1> Specification:
- 1> Operating force: 1000gf Max
 - 2> Operating Temperature: -40° to +85°
 - 3> Storage Temperature: -40° to +85°
 - 4> Mechanical Life: 3000cycles minimum
 - 5> Electrical Life: 2000cycles 25mA 24VDC
2. PLATING:
- GOLD FLASH 1u"(min.) SOLDER TAIL,
3u" GOLD PLATING ON THE CONTACT AREA,
WITH 50u" NICKEL UNDERPLATING OVERALL.

3. PART NUMBER DESCRIPTION

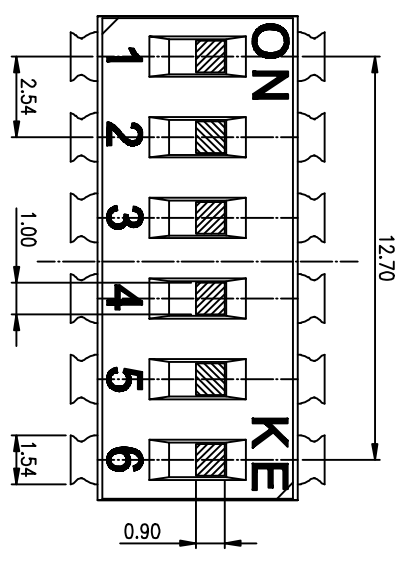
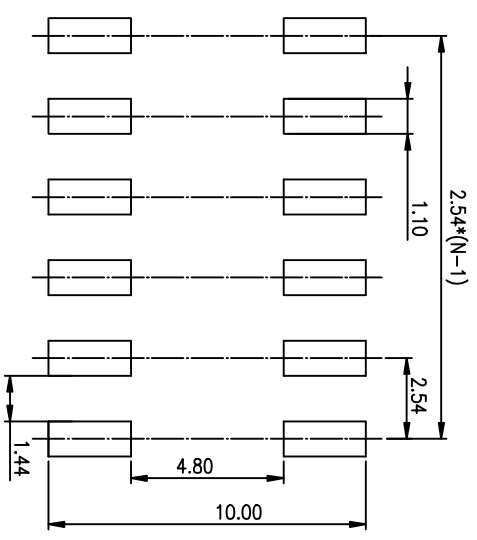
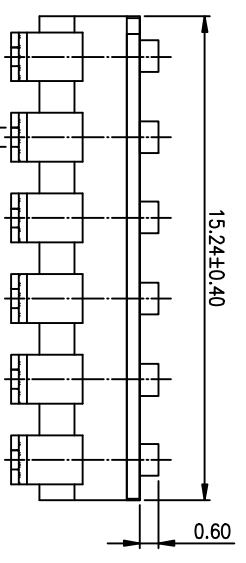
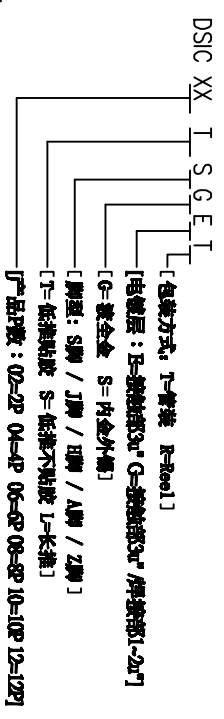

RECOMMENDED P.C.B. LAYOUT (TOP VIEW)

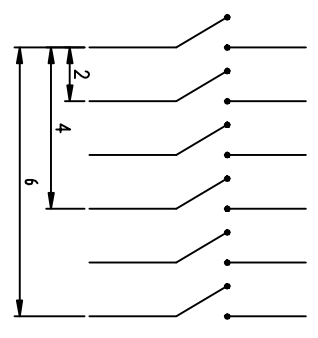

[Schematic]

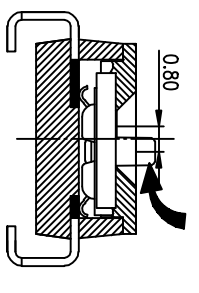

(Construction)

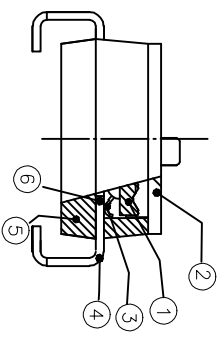

Number	Part Name	Material	Finished
①	Actuator	UL94 V0	White
②	Cover	UL94 V0	Black
③	Movable	Copper Alloy	3u"Gold
④	Terminal	Brass	1u"Gold
⑤	Base	UL94 V0	Black
⑥	Terminal Contact	Brass	3u"Gold

TOLERANCE UNLESS OTHERWISE SPECIFIED		INSPECTION COPY	
LINER	ANGLES	PROJECTION	COPY
0 ± 0.25	0. ± 2'	⊕	
.00 ± 0.15	.0 ± 1'	⊖	
.000± 0.10	.00± 0.5'		
DESIGN	kathy	2012/04/12	
DRAWING			
CHECK			
APPRO.			

東富精機電子股份有限公司
Dongguan Kingtek Industrial Co., Ltd.

BY DISC SERIES PITCH 2.54mm

PRODUCT FAMILY DISC SERIES

PRAT NO. DISC06LJGET

FILE NO. DISC06LJGET-A

SIZE UNIT SCALE SHEET REV.

A4 mm 2 : 1 1OF 1 A